

BANNER[®]

the photoelectric specialist

VS3 Opposed-Mode Sensors

Miniature Self-Contained Emitters and Receivers

CE



VS3 Opposed-Mode Sensor Features

- Extremely compact self-contained miniature sensor
- 10 to 30V dc operation
- Visible red sensing beam
- Choose dark- or light-operate models
- Choose models with NPN (sinking) or PNP (sourcing) output
- 2-wire (emitter) or 3-wire (receiver) hookup; output load capacity to 50 mA
- Choice of integral cable or quick-disconnect connector

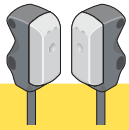

Visible red, 660 nm

VS3 Series Opposed-Mode Emitter (E) and Receiver (R) Models

Models*	Range	Cable	Supply Voltage	Output Type	Excess Gain	Beam Pattern
VS3KAN5V Sensor Pair VS35EV Emitter VS3AN5R Receiver	1.2 m (3.96')	2 m (6.5') 2 wires 3 wires	10 to 30V dc	NPN/ Light Operate		
VS3KAN5VQ Sensor Pair VS35EVQ Emitter VS3AN5RQ Receiver		3-Pin Pico QD		NPN/ Light Operate		
VS3KRN5V Sensor Pair VS35EV Emitter VS3RN5R Receiver		2 m (6.5') 2 wires 3 wires		NPN/ Dark Operate		
VS3KRN5VQ Sensor Pair VS35EVQ Emitter VS3RN5RQ Receiver		3-Pin Pico QD		NPN/ Dark Operate		
VS3KAP5V Sensor Pair VS35EV Emitter VS3AP5R Receiver		2 m (6.5') 2 wires 3 wires		PNP/ Light Operate		
VS3KAP5VQ Sensor Pair VS35EVQ Emitter VS3AP5RQ Receiver		3-Pin Pico QD		PNP/ Light Operate		
VS3KRP5V Sensor Pair VS35EV Emitter VS3RP5R Receiver		2 m (6.5') 2 wires 3 wires		PNP/ Dark Operate		
VS3KRP5VQ Sensor Pair VS35EVQ Emitter VS3RP5RQ Receiver		3-Pin Pico QD		PNP/ Dark Operate		

*NOTE: Sensors may be purchased in pairs, or individually.

**WARNING . . . Not To Be Used for Personnel Protection****Never use these products as sensing devices for personnel protection. Doing so could lead to serious injury or death.**

These sensors do NOT include the self-checking redundant circuitry necessary to allow their use in personnel safety applications. A sensor failure or malfunction can cause either an energized or de-energized sensor output condition. Consult your current Banner Safety Products catalog for safety products which meet OSHA, ANSI and IEC standards for personnel protection.

VS3 Opposed-Mode Sensors

VS3 Opposed-Mode Sensor Specifications

Supply Voltage and Current	10 to 30V dc (10% maximum ripple) at less than 25 mA (exclusive of load)
Supply Protection Circuitry	Protected against reverse polarity and transient voltages
Output Configuration	SPST solid-state switch Choose NPN (current sinking) or PNP (current sourcing) models Choose light operate (N.O.) or dark operate (N.C.) models
Output Rating	50 mA maximum Off-state leakage current: < 1 microamp at 24V dc On-state saturation voltage: < 0.25V at 10 mA dc; < 0.5V at 50 mA dc
Output Protection Circuitry	Protected against false pulse on power-up and continuous overload or short circuit of outputs Overload trip point ≥ 100 mA
Output Response Time	1 millisecond ON and 0.5 millisecond OFF (NOTE: 100 millisecond delay maximum on power-up; output does not conduct during this time)
Repeatability	100 microseconds
Indicators	Two LEDs: Green and Yellow Green ON steady = power to sensor is ON Green flashing = output overload Yellow ON steady = light is sensed Yellow flashing = marginal excess gain (1-1.5x) in light condition
Construction	Black ABS housing with acrylic lens
Environmental Rating	IEC IP67; NEMA 6
Connections	2 m (6.5') attached cable: #28 ga stranded conductors with PE insulation; PVC outer cable jacket; or 3-pin Pico-style threaded quick-disconnect fitting. QD cables are ordered separately (see page 3).
Operating Conditions	Temperature: -20° to +55°C (-4° to +131°F) Maximum Relative Humidity: 80% at 50°C (non-condensing)
Vibration and Mechanical Shock	Vibration: All models meet IEC 60068-2-6, IEC 60947-5-2, UL491 Section 40, MIL-STD-202F Method 201A; 10 to 60 Hz, 0.5 mm peak to peak Shock: All models meet IEC 60068-2-27, IEC 60947-5-2; 30g peak acceleration, 11 millisecond pulse duration, half-sine wave pulse shape
Application Notes	M3 stainless steel mounting hardware included. Optional mounting brackets are available (page 4).
Certifications	

VS3 Opposed-Mode Sensor Hookups

**Emitters
Cabled Hookup**

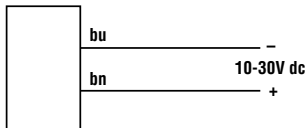

**Receivers with NPN Outputs
Cabled Hookup**

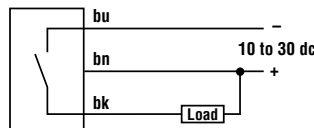

**Receivers with PNP Outputs
Cabled Hookup**

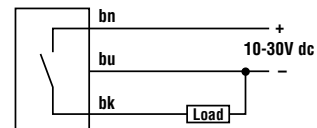

Quick-Disconnect Hookup

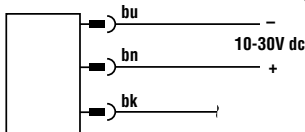

Quick-Disconnect Hookup

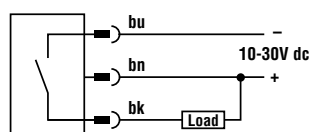

Quick-Disconnect Hookup

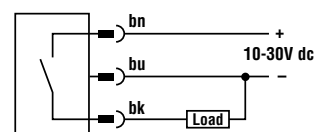

VS3 Opposed-Mode Sensors

VS3 Opposed-Mode Dimensions

Cabled Models

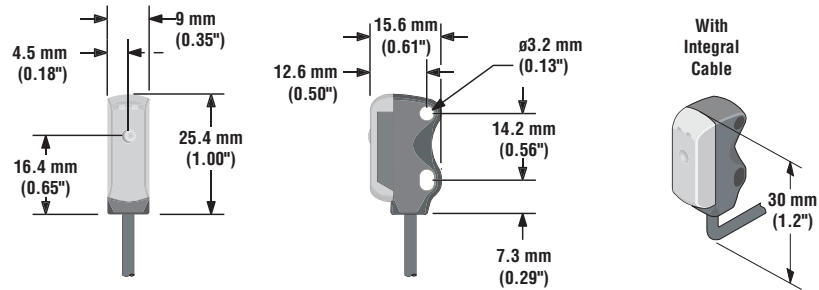

Quick-Disconnect Models

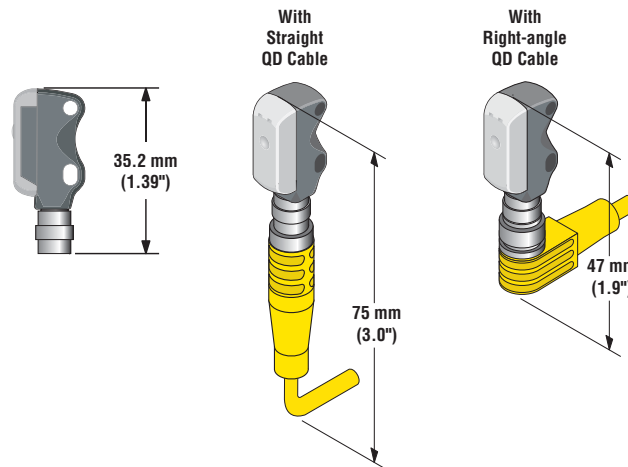



Accessories

Quick-Disconnect (QD) Cables

Style	Models	Length	For Use With	Dimensions	Pinout
3-pin Pico-Style Straight	PKG3M-2 PKG3M-9	2 m (6.5') 9 m (30')	All VS3 Series sensors with model suffix "Q".		
3-pin Pico-Style Right-Angle	PKW3M-2 PKW3M-9	2 m (6.5') 9 m (30')			

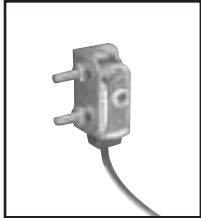
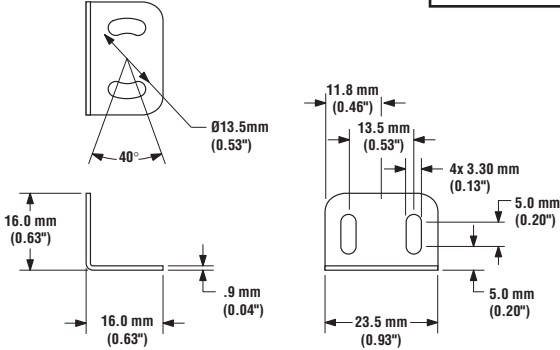
VS3 Opposed-Mode Sensors

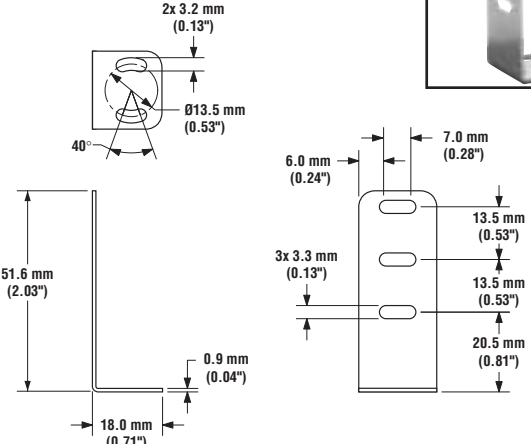
VS3 Mounting Brackets	
SMBVS3S <ul style="list-style-type: none"> • Right-angle bracket • 300 series stainless steel 	SMBVS3T <ul style="list-style-type: none"> • Right-angle tall bracket • 300 series stainless steel
 	 



WARRANTY: Banner Engineering Corp. warrants its products to be free from defects for one year. Banner Engineering Corp. will repair or replace, free of charge, any product of its manufacture found to be defective at the time it is returned to the factory during the warranty period. This warranty does not cover damage or liability for the improper application of Banner products. This warranty is in lieu of any other warranty either expressed or implied.